



## QV Series QIC2™ Compact Ball Valves

1/2" TO 2" PVC

### KEY FEATURES

- Gray PVC
- Rugged, Compact and Lightweight Design
- Full Port Design
- Socket or Threaded Ends
- PTFE Seats
- EPDM O-Ring Seals
- Low Torque, Easy 1/4-Turn Operation
- No Integral Parts to Replace
- Perfect for OEM Requirements

## QTA Series True Union Compact Ball Valves

1/2" TO 2" PVC

### KEY FEATURES

- Gray and White PVC
- True Union End Connections
- Rated at a Full 150 PSI
- Santoprene® (TPV) Seats
- EPDM O-Ring Seals
- No Internal Parts to Replace
- Low Torque Easy 1/4-Turn Operation
- Perfect for OEM Applications
- Socket and Threaded End Connections



## QVC Series Compact Ball Valves

1/2" TO 4" PVC

### KEY FEATURES

- Gray and White PVC
- Compact and Lightweight Design
- Low Torque Easy 1/4-Turn Operation
- Santoprene® (TPV) Seats
- EPDM O-Ring Seals
- No Internal Parts to Replace

\*Note: 4" Sizes have Lever Handle not T-handle

# QV Series, QTA Series & QVC Series

TECHNICAL INFORMATION

## QV SERIES QIC2™ COMPACT BALL VALVES

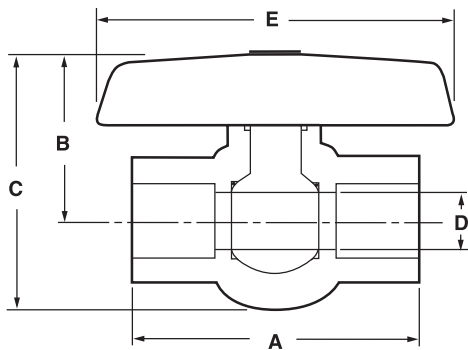

### OPERATING TEMPERATURE/PRESSURE

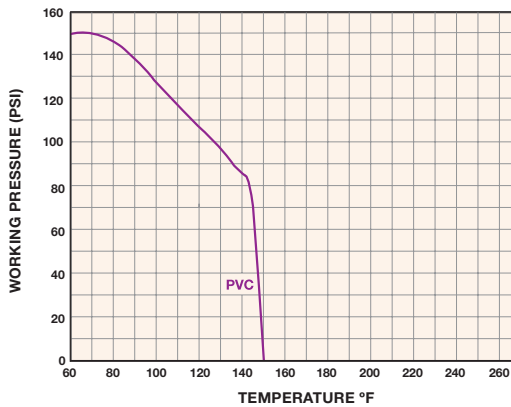

## QTA SERIES TRUE UNION COMPACT BALL VALVES

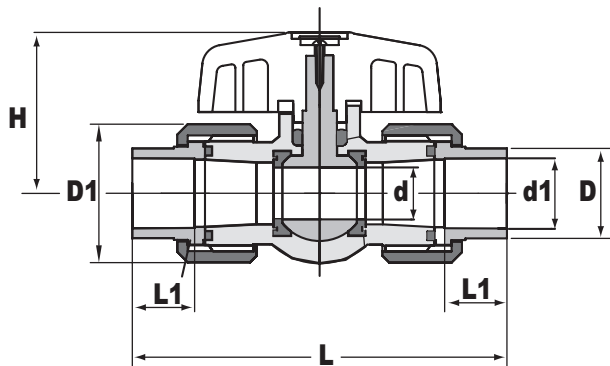

### OPERATING TEMPERATURE/PRESSURE

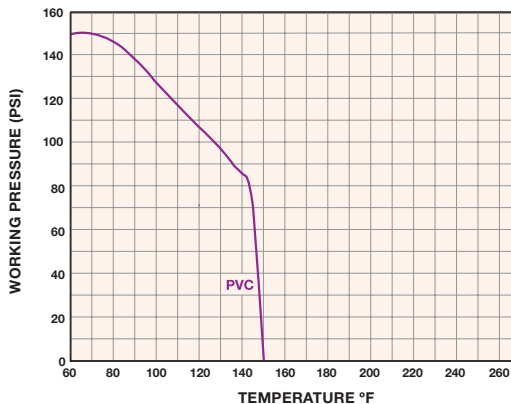

## QVC SERIES COMPACT BALL VALVES

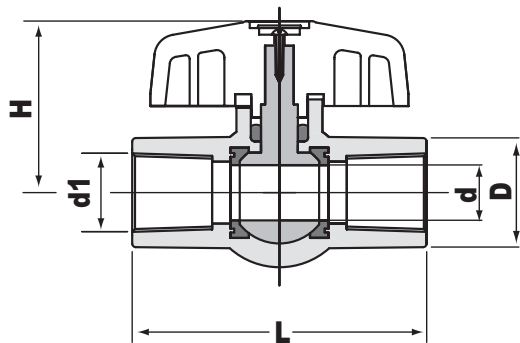

### OPERATING TEMPERATURE/PRESSURE

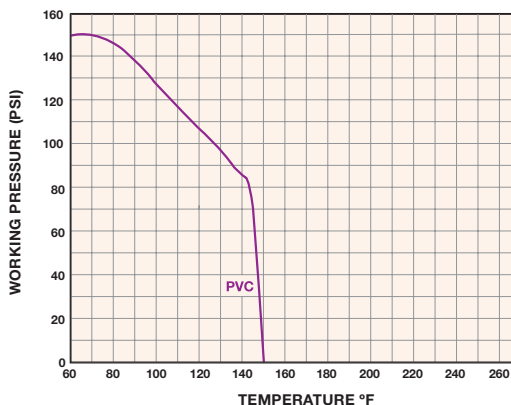

Hayward is a registered trademark of Hayward Industries, Inc. © 2021 Hayward Industries, Inc.

USA: 1.888.429.4635 • Fax: 1.888.778.8410 • One Hayward Industrial Drive • Clemmons, NC 27012 • Email: hfcsales@hayward.com  
 Canada: 1.888.238.7665 • Fax: 1.905.829.3636 • 2880 Plymouth Drive • Oakville, ON L6H 5R4 • Email: hflowcanada@hayward.com  
 Visit us at: haywardflowcontrol.com